

Magnescape

Software

MeasureViewer (US)

Read all the instructions in the manual carefully before use and strictly follow them.
Keep the manual for future references.
This instruction manual corresponds to the software Ver. 1.0.2.

Instruction Manual

Trademarks

Microsoft Windows is a registered trademark of Microsoft Corporation.

Intel® Core™i3 is a registered trademark of Intel Corporation.

Install Shield® is a registered trademark of Flexera Software, Inc.

Other system names, product and service names described in the instruction manual are trademarks or registered trademarks of their corresponding manufacturers.

IN NO EVENT WILL MAGNESCALE CO., LTD. OR ITS SUPPLIERS BE LIABLE FOR ANY CONSEQUENTIAL OR INCONSEQUENTIAL DAMAGES, INCLUDING BUT NOT LIMITED TO, LOST PROFITS, LOST SAVINGS, OR ANY THIRD PARTY CLAIMS ARISING OUT OF USE OF THE SOFTWARE AND PROTECTION DONGLE DESCRIBED IN THIS MANUAL.

The specifications of this software may be changed without prior notice.

This application has been confirmed to operate properly on Microsoft Windows 10, version 1607.

Its operation is not guaranteed on future updates of Microsoft Windows 10.

Contents

1. Outline	1
1-1. Introduction	1
1-2. Major functions	1
2. System environment and setup	2
2-1. Compatible measuring units	2
2-2. Recommended operating environment	2
2-3. PC settings	2
3. Installation/uninstallation.....	3
3-1. Installation.....	3
3-2. Uninstallation	7
4. Starting up and ending the application	8
4-1. Starting up MeasureViewer.....	8
4-2. Ending MeasureViewer	9
5. Window composition	10
5-1. Area composition	10
5-2. Changing the layout of the areas.....	10
5-3. Changing the layout of the measuring unit displays	11
6. Functions and operations.....	12
6-1. Measuring unit area	12
6-1-1. Measurement value display	12
6-1-2. Selecting the measurement value display.....	13
6-1-3. Selecting the measurement mode.....	14
6-1-4. Selecting the unit	14
6-1-5. Center value setting.....	15
6-1-6. Measurement value operations.....	15
6-1-7. Detailed settings.....	16
6-2. Line chart area	17
6-2-1. Line chart zoom-in/out and tracker display	18
6-3. Data save function area	19
6-4. Common functions	21
6-4-1. Application information and measurement value display operations.....	21
6-4-2. CSV format data output and initialization settings	22
6-5. Switching the display unit between mm and inch	23

7. Troubleshooting..... 25

7-1. An alarm occurred25
7-2. The installation failed25
7-3. The application won't start.....25
7-4. A measuring unit is not displayed, or the numeric values are not updated.. 26
7-5. The application suddenly shuts down27

1. Outline

1-1. Introduction

MeasureViewer is a software application (the application) that displays values measured by measuring units on a PC running Microsoft Windows (the PC).

To use the application, you must connect a compatible measuring unit (or units) to the PC.

About the dedicated protection dongle

A dedicated protection dongle is required at all times when using the application. Even if the application is properly installed on the PC, a forced shutdown will occur after five minutes if the protection dongle is not connected to one of the PC's USB ports.

1-2. Major functions

Measurement value display

- Display format selection (numeric value, bar display, analog meter)
- Current value, minimum value, maximum value, P-P value
- Four-step threshold value judgment
- Line chart (all axes)
- Display range switching
- mm/ μ m unit switching

Data output

- Selection and storage of current value, minimum value, maximum value, or P-P value
- Output (saving) of acquisition interval, measurement values, and threshold determinations in CSV format
- Output of line charts (image, CSV data)

Operations

- Measurement value display format switching (numeric value, bar meter, analog meter)
- Decimal point setting
- Reset, preset, peak hold, latch, start
- Preset value setting
- Threshold setting
- Cyclic data acquisition
- Designation of data save format (Selectable from Japanese, U.S., or European formats)

2. System environment and setup

2-1. Compatible measuring units

Manufactured by Magescale Co., Ltd.

Measuring unit	Description
DS800S series DS series	Measuring unit for USB connection
DT series	An MT30 series interpolator (sold separately) is required for USB connection.

Number of measuring units that can be connected

Up to 16

2-2. Recommended operating environment

OS	Microsoft Windows 10
CPU	Intel Core i3 or higher recommended
Memory	32-bit: 2 GB or more recommended 64-bit: 4 GB or more recommended
Storage	Min. 200 MB
Display resolution	1,280 × 800 or higher recommended
Communication interface	USB 2.0 or higher
Execution environment	.NET Framework 4.6 or later

The following software programs are also installed when the application is installed.

- USBSerial4MgsGauge.ocx : ActiveX is required for communication with the measuring unit.
- Microsoft VisualC++ 2017 SP1 runtime : ActiveX operating environment

Note

Microsoft VisualC++ 2017 SP1 runtime is not automatically uninstalled when the application is uninstalled. When uninstallation is necessary, uninstall each software program separately.

2-3. PC settings

Disable sleep mode on the PC.

If the PC enters sleep mode, operation may be unstable after it awakes from sleep.

3. Installation/uninstallation

3-1. Installation

- 1 Insert the Installer USB Memory into a USB port of the PC.
- 2 Start up the installer program on the USB flash drive. Installation starts.
- 3 Select the installation language and click the “OK.”

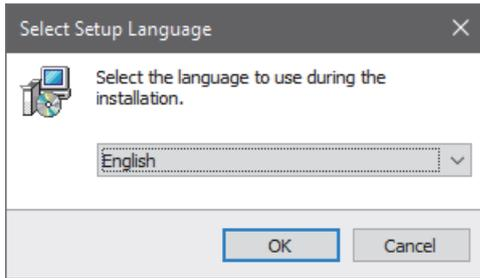

The Welcome to the MeasureViewer Setup Wizard window appears.

- 4 Click the “Next>.”

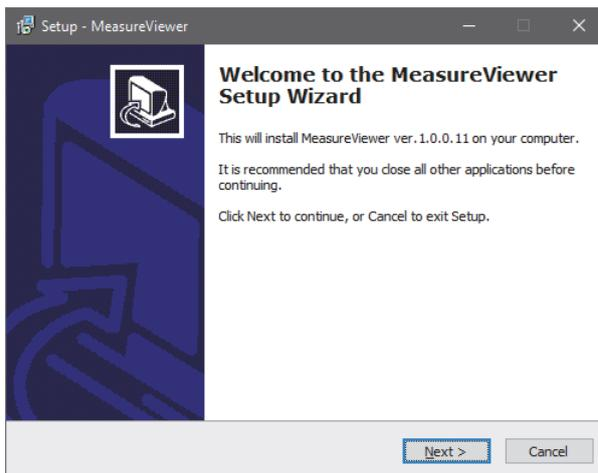

The Software License Agreement appears.

5 If you agree to the displayed license conditions, select “I accept the agreement” and then click “Next>.”

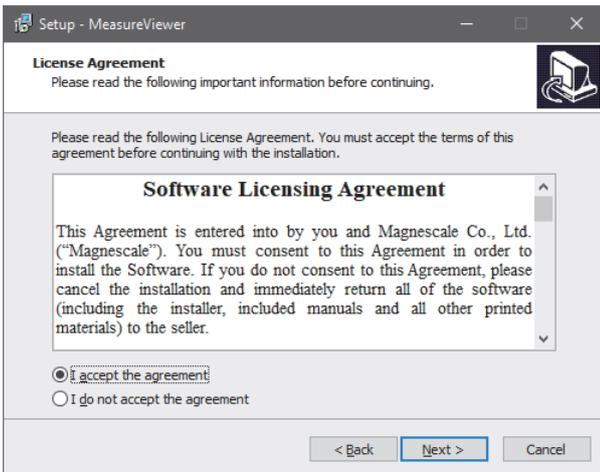

The Select Destination Location window appears.

6 Select the install destination location and then click the “Next>.”

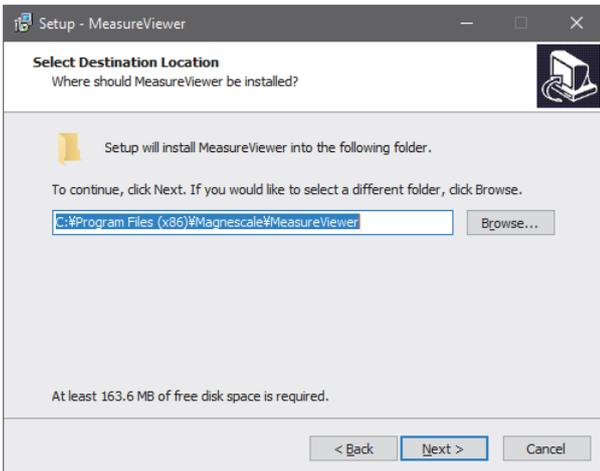

The Select Components window appears.

7 Click “Next>.”

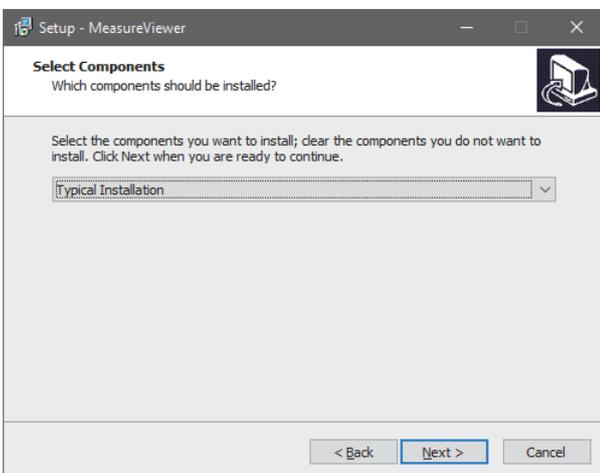

The Select Start Menu Folder window appears.

- 8 Select the folder in which the program's shortcuts will be created and click "Next>."

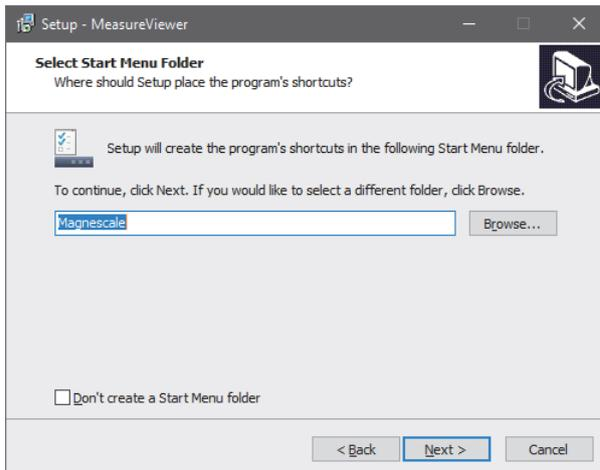

The Select Additional Tasks window appears.

- 9 Check the box for Create a desktop shortcut if desired, and click "Next>."

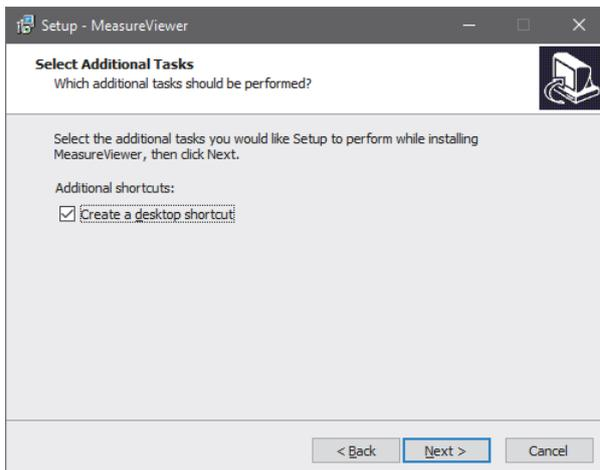

This completes the preparations for installation.

- 10 Click "Install."
Installation starts.

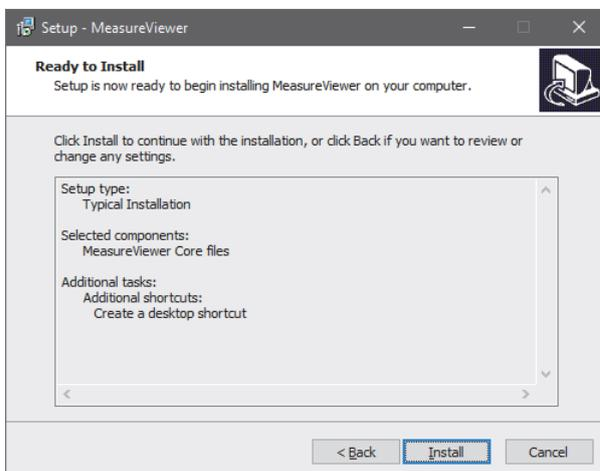

- 11 In parallel with installation of the application, the runtime required for operation of the measuring unit is also installed.

Check the box for I agree to the license terms and conditions and then click “Install.”

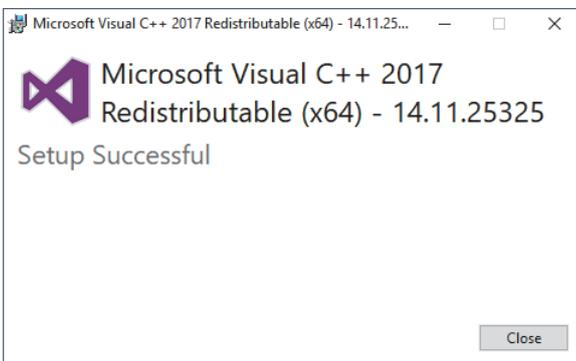
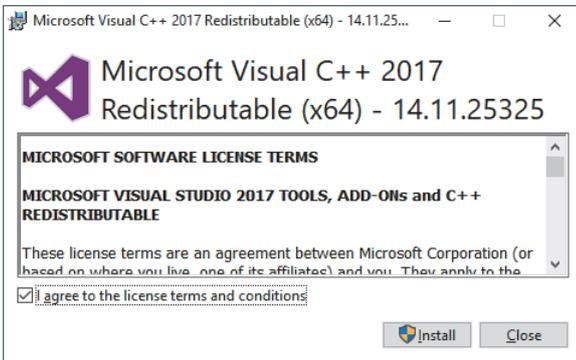

- 12 When the following window appears, click “Finish.”

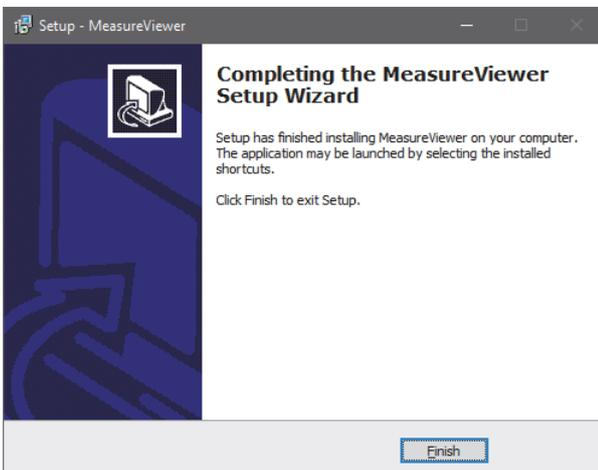

The installation is complete.

3-2. Uninstallation

1 On the Windows 10 Start menu, select Settings → Apps → Apps & features.

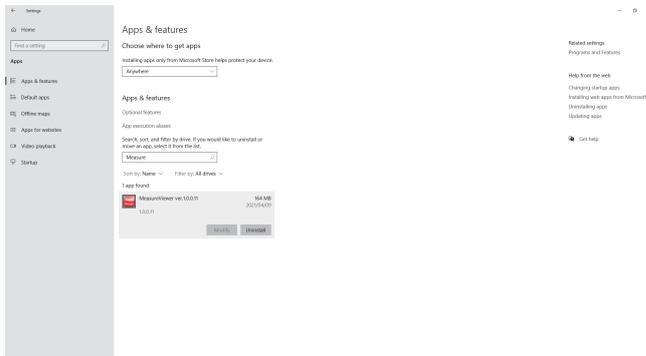

2 Under “Apps & features”, select MeasureViewer and then click “Uninstall.”

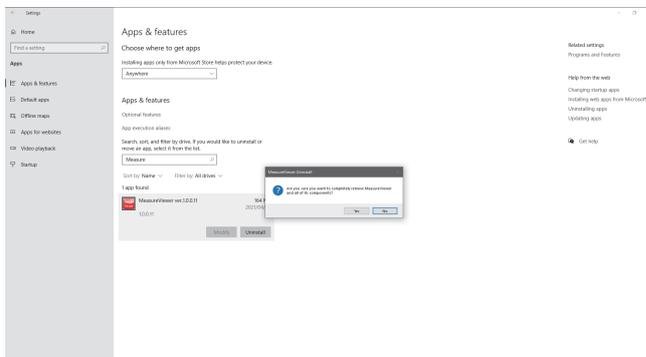

3 When “MeasureViewer was successfully removed from your computer.” is displayed, uninstallation is complete.

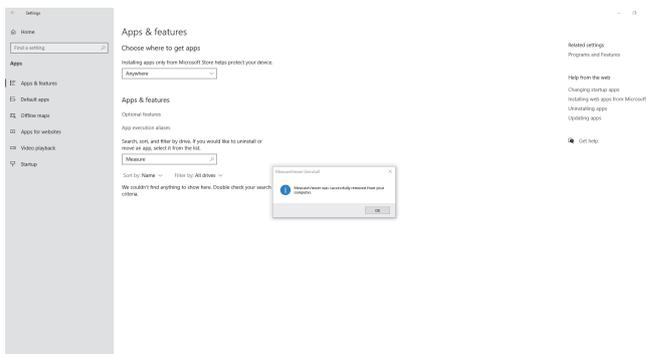

4 To uninstall the Microsoft VisualC++ 2017 SP1 runtime, select VisualC++ 2017 for uninstallation using the procedure described in steps 1 and 2 above.

4. Starting up and ending the application

4-1. Starting up MeasureViewer

- 1 Confirm that the protection dongle is connected to one of the PC's USB ports.
- 2 Click the shortcut created during the installation process.
MeasureViewer starts.
All the measuring units currently recognized by the PC are displayed in the measuring unit (Gauges) area.

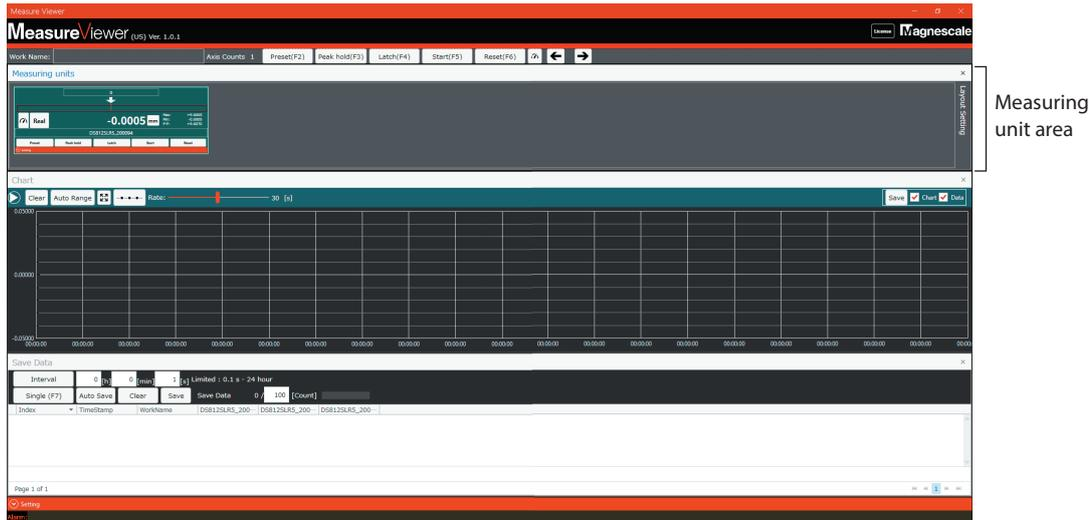

If data previously acquired by the data save function (see section 6-3) exists

The following message appears when the application is started. To restore the previous data, click “OK.”

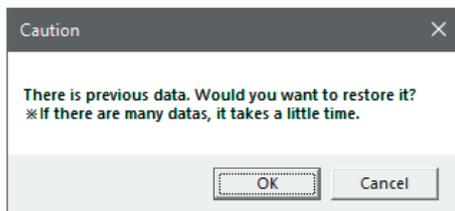

Note

Leave the protection dongle connected to the PC's USB port while the application is in use. The software license is not recognized if the protection dongle is not connected, and a forced shutdown occurs after five minutes has elapsed.

Window displayed if software license (protection dongle) is not recognized

< License alert message >

After clicking “OK”, the application can only be used for five more minutes.

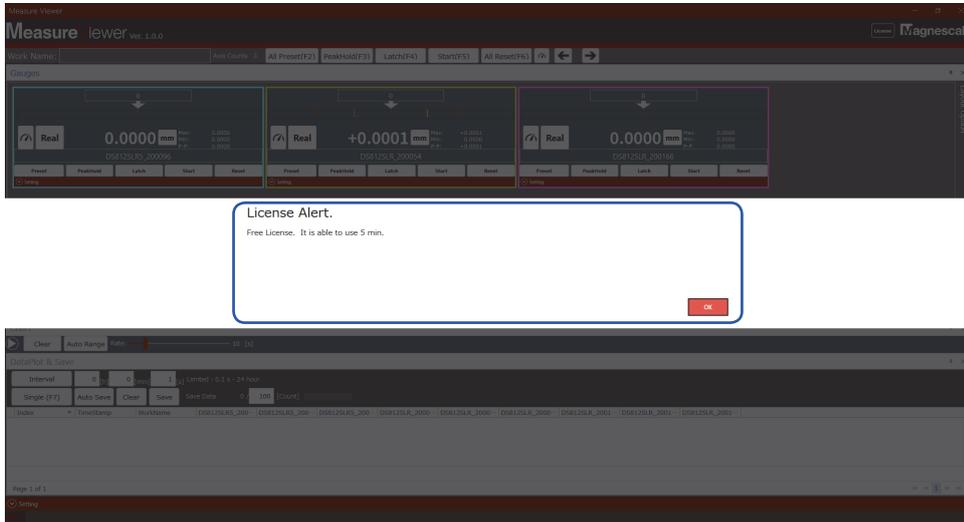

< App shutdown message >

After five minutes has elapsed, an app shutdown message appears followed by a forced shutdown.

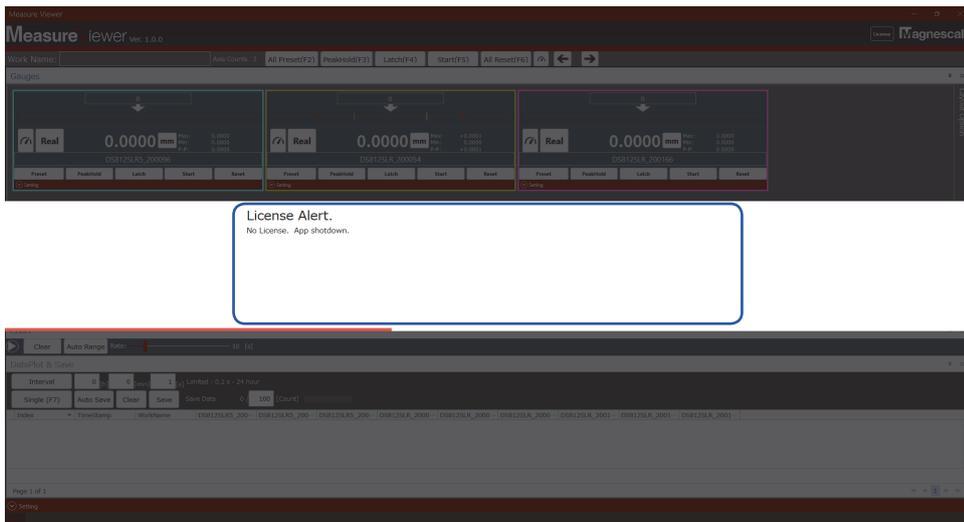

4-2. Ending MeasureViewer

Click the “× (Close)” at the upper right corner of the MeasureViewer window to end the application.

When ending the application, the following message appears.

Click “OK” to end MeasureViewer.

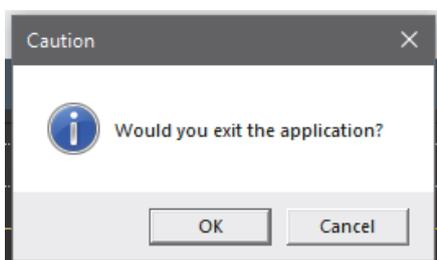

5. Window composition

5-1. Area composition

The MeasureViewer window is composed of three areas.

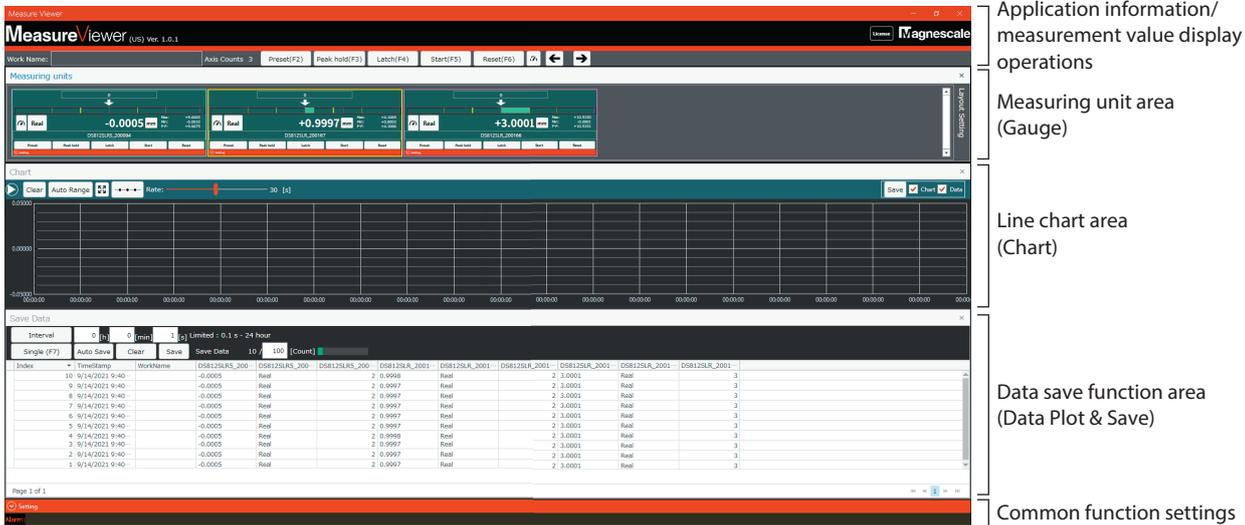

Measuring unit area (Gauge) Measuring unit measurement value display, individual settings (See section 6-1.)

Line chart area (Chart) Realtime graphical display of current values from selected measuring units (See section 6-2.)

Data save function area (Data Plot & Save) Acquisition and storage of data from all measuring units (See section 6-3.)

Refer to section 6-4 for information on using these areas for checking application information, measurement value display operations, and common function settings.

5-2. Changing the layout of the areas

The layout and size of the measuring unit area and data save function area can be changed.

The line chart area changes automatically to match changes made to the measuring unit area or data save function area.

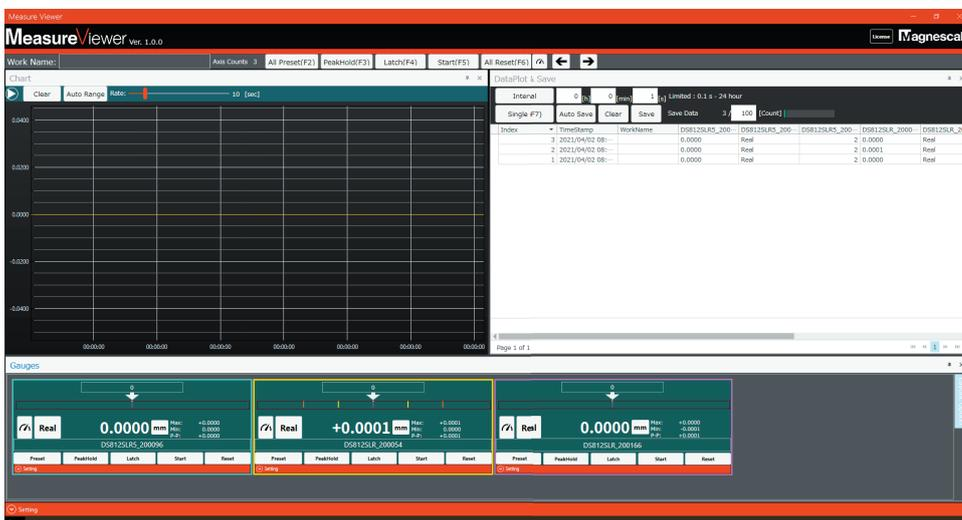

Click “× (Close)” at the upper right corner of a display area to minimize the area to the bottom of the MeasureViewer window above “Setting.”
 To redisplay an area, click its name.

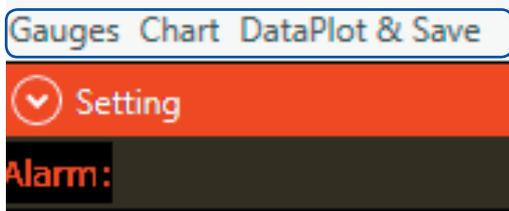

5-3. Changing the layout of the measuring unit displays

The layout and size of the measuring unit displays within the measuring unit area can be changed. Move the cursor to the Layout Option box at the right of the measuring unit area to display the layout setting items. The layout can be changed freely to match the window being used.

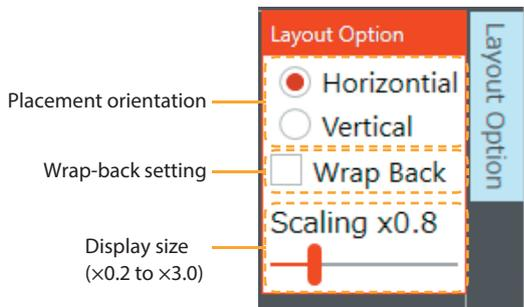

< Layout examples >

Horizontal placement, wrap-back off

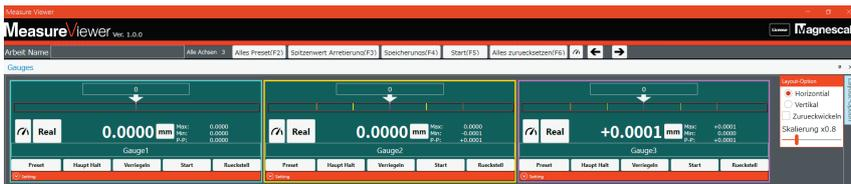

Vertical placement, wrap-back off



Horizontal placement, wrap-back on

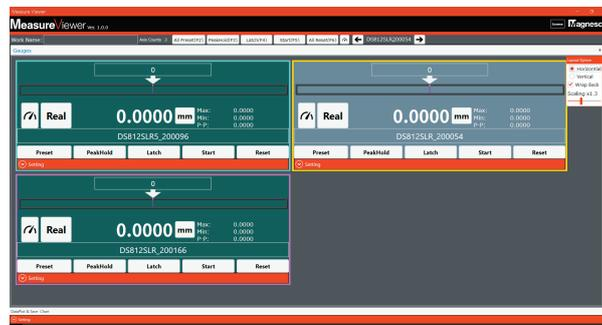

6. Functions and operations

6-1. Measuring unit area

The measurement values of the recognized measuring units are displayed in the measuring unit area.

6-1-1. Measurement value display

The measurement value display switching options and setting functions for each measuring unit are as follows.

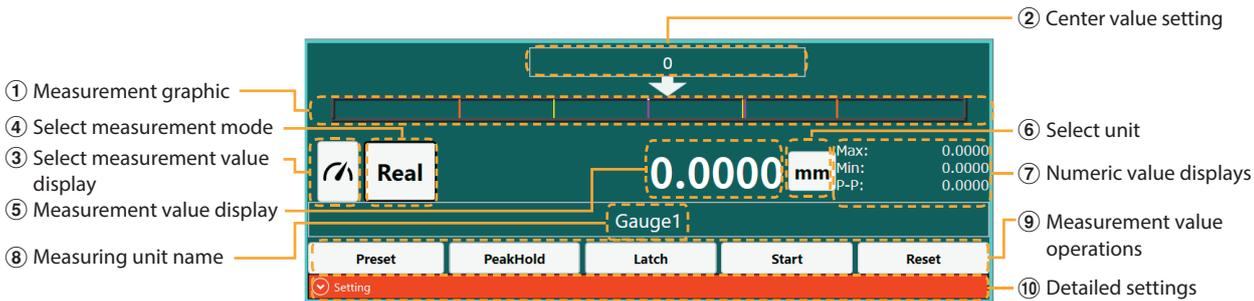

① Measurement graphic	Displays the current value in graphical format. Refer to the description of comparator value settings for information on display colors (See section 6-1-7).
② Center value setting	Sets the value displayed in the center of ①. (See section 6-1-5.)
③ Select measurement value display	Selects the visual display of ①. (See section 6-1-2.) The display setting switches through the following sequence: numeric value display → horizontal bar graph display → vertical bar graph display → analog meter display.
④ Select measurement mode	Selects the measurement mode displayed. (See section 6-1-3.) Real : current value Max : maximum value Min : minimum value P-P : maximum value - minimum value
⑤ Measurement value display	Displays the measurement value in the specified measurement mode.
⑥ Select unit	Selects the display unit between mm and μm. (See section 6-1-4.)
⑦ Numeric value displays	Displays the maximum value, minimum value, and P-P value.
⑧ Measuring unit name	The name assigned to the measuring unit. The initial setting is measuring unit model name_serial number.
⑨ Measurement value operations	The operation buttons are as follows. (See section 6-1-6.) Preset : Applies the specified preset value to the measurement value. PeakHold: Halts updating of the maximum value, minimum value, and P-P value. Latch : Halts updating of the current value, maximum value, minimum value, and P-P value. Start : Sets the maximum value and minimum value to the current value and the P-P value to 0. Reset : Sets the measurement value to 0.
⑩ Detailed settings	Click this item to enter settings for items such as the range value and comparator values. (See section 6-1-7.)

6-1-2. Selecting the measurement value display

Press the select button to select among the measurement value display modes.

Switch button



Numeric value display

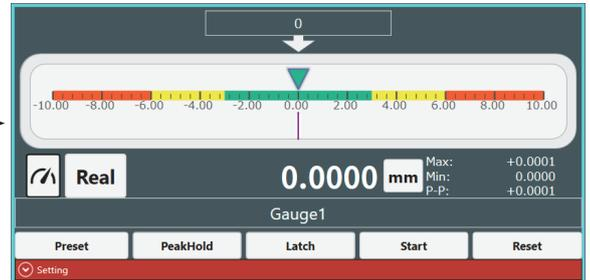

Horizontal bar graph display

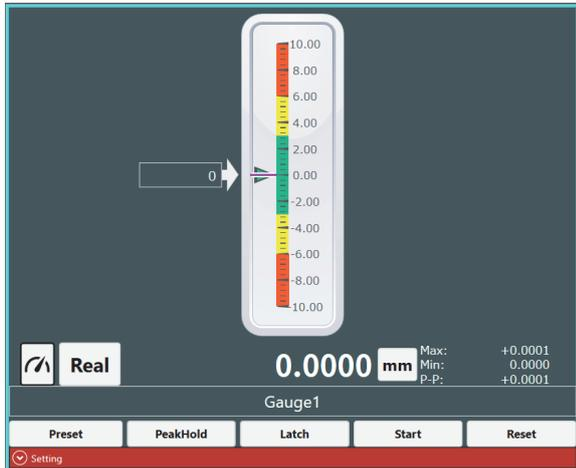

Vertical bar graph display

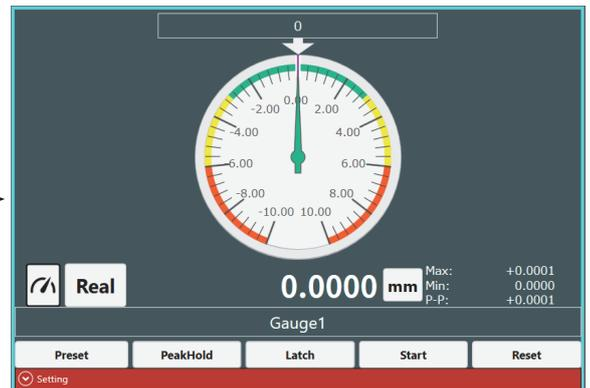

Analog meter display

6-1-3. Selecting the measurement mode

The measurement mode used for the display (current value, maximum value, minimum value, or P-P value) can be changed.

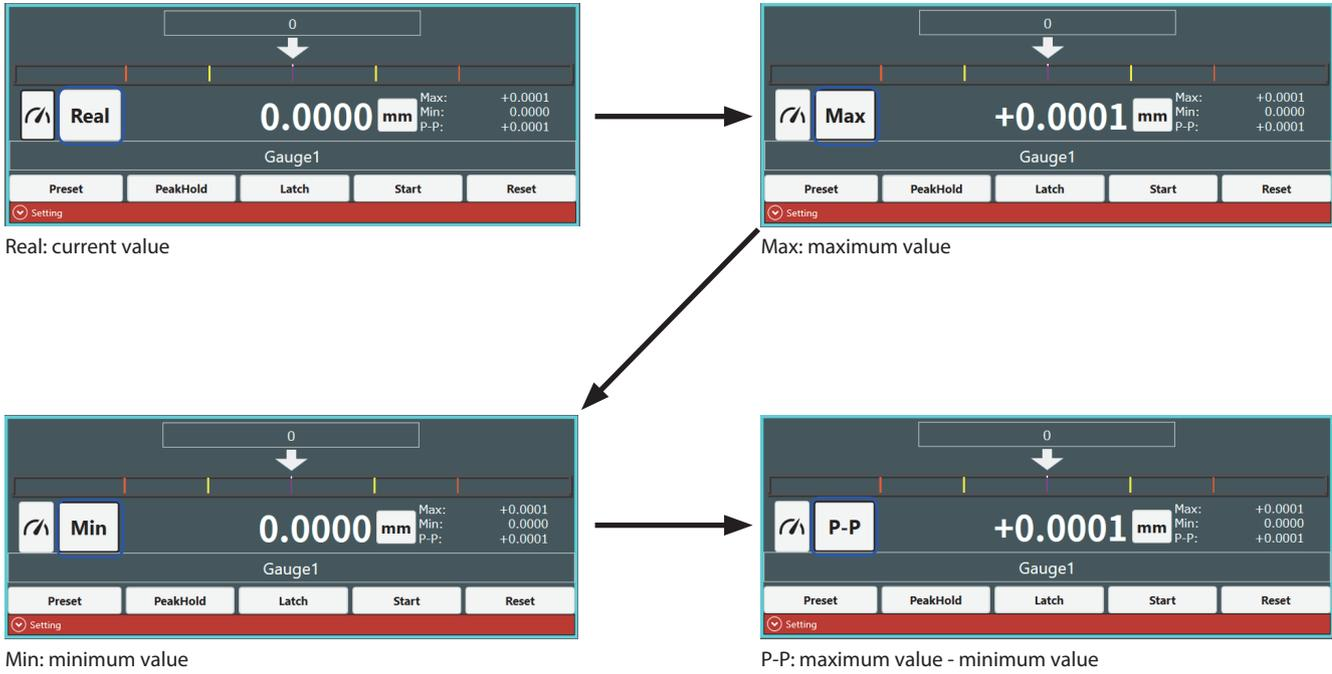

6-1-4. Selecting the unit

The display unit for measurement values can be switched between mm and μm .

The number of digits displayed after the decimal point changes automatically when the unit is changed.

The setting for the number of digits displayed after the decimal point can be changed (see section 6-1-7), but the initial settings are as follows.

mm: Display up to the 4th decimal place.

μm : Display up to the 1st decimal place.

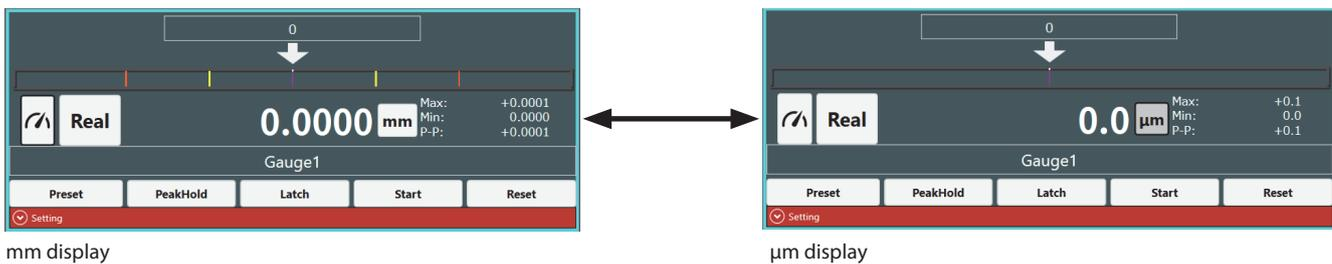

To switch the unit to inch, refer to section "6-5. Switching the display unit between mm and inch."

6-1-5. Center value setting

The center value of the measurement graphic display can be specified.
 The threshold used for pass/fail determination is a relative value from the center value.
 For the relationship between the center value and the threshold, refer to section 6-1-7.

< Example >

Measuring a part with a tolerance specification of $2,000 \mu\text{m} \pm 15 \mu\text{m}$.

Display unit setting : μm

Center value setting : 2000

Range setting : 15 (See section 6-1-7.)



6-1-6. Measurement value operations

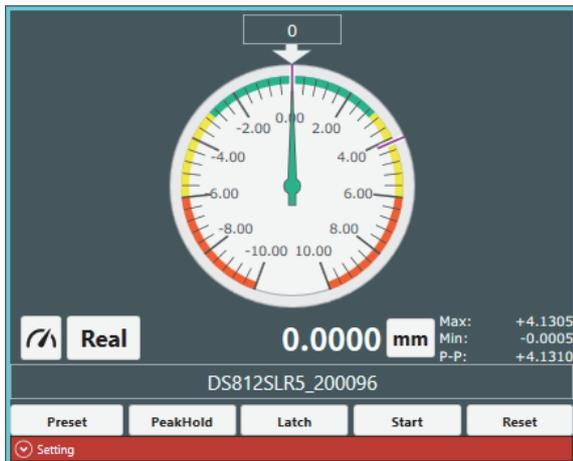

The operation buttons can be used to update or stop updating of the measurement values (current value, maximum value, minimum value, P-P value).

	Preset	PeakHold	Latch	Start	Reset
Current value	Apply preset value*	Update	Stop	Update	Set to 0
Maximum value	Apply preset value*	Stop	Stop	Set to current value	Set to 0
Minimum value	Apply preset value*	Stop	Stop	Set to current value	Set to 0
P-P value	Set to 0	Stop	Stop	Set to 0	Set to 0

* Refer to section 6-1-7 regarding setting the preset value.

Note

PeakHold on (button color blue) : Preset and Reset are disabled.

Latch on (button color blue) : Preset, Start, and Reset are disabled.

6-1-7. Detailed settings

Click  to open the panel as shown, allowing you to enter detailed settings.

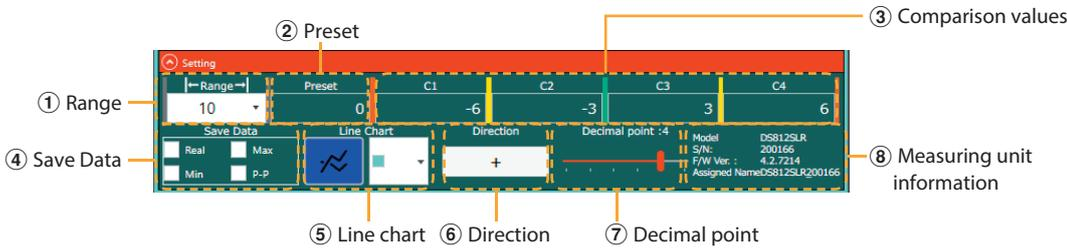

① Range	<p>Specifies the range from the center value for the visual display of the measurement value. Settings from 0.05 μm to 250 mm can be entered to match the display unit. The range can be set to match the display unit. (For the display unit, refer to section "6-5. Switching the display unit between mm and inch.")</p> <p>mm / μm: 0.05, 0.1, 0.25, 0.5, 1, 2.5, 5, 10, 15, 25, 30, 50, 100, 250 inch: 0.0000025, 0.000005, 0.000025, 0.00005, 0.00025, 0.0005, 0.0025, 0.005, 0.025, 0.05, 0.25, 0.5, 2.5, 5</p>												
② Preset	<p>Sets the preset value.</p> <p>When the display unit is mm/μm Entry range: ± 99999.99999 When the display unit is inch Entry range: ± 99999.99999</p>												
③ Comparison values	<p>Sets the judgment threshold for the measurement value.</p> <p>When the display unit is mm/μm Entry range: ± 99999.99999 When the display unit is inch Entry range: ± 99999.99999</p> <p>To specify four steps: Enter values such that $C1 < C2 < C3 < C4$. To specify two steps: Enter setting such that C2 and C3 have the same respective values as C1 and C4.</p> <p>The comparison judgment uses measurement values in the selected measurement mode. The judgment is based on the following relationship among comparison values: $C1 < C2 \leq \text{measurement value} < C3 < C4$. (Red) (Yellow) (Green) (Yellow) (Red)</p> <p>Note If the same numeric value is specified for C1 to C4, no judgment will take place.</p>												
④ Save Data	<p>Selects the data output in the data save function area.</p> <p>Real: current value Max: maximum value Min: minimum value P-P: P-P value When not selected, the currently displayed value is saved.</p>												
⑤ Line chart	<p>Specifies the color of the graph displayed in the line chart area.</p> <p>To disable display in the line chart area, click the icon to turn it off. On: blue icon Off: white icon</p>												
⑥ Direction	<p>Switches the count direction of the measurement value display.</p> <p>When the spindle of the measuring unit is depressed, the count is incremented when [+] is selected and decremented when [-] is selected.</p>												
⑦ Decimal point	<p>Specifies the number of display digits after the decimal point. The initial setting and the setting range differ according to the display unit.</p> <table border="1" data-bbox="491 1677 1267 1861"> <thead> <tr> <th>Unit</th> <th>Initial setting</th> <th>Setting range</th> </tr> </thead> <tbody> <tr> <td>mm</td> <td>4</td> <td>0 to 5</td> </tr> <tr> <td>μm</td> <td>1</td> <td>0 to 5</td> </tr> <tr> <td>inch</td> <td>According to the resolution of the measuring unit 0.5 μm: 5 0.1 μm: 6</td> <td>0 to 7</td> </tr> </tbody> </table>	Unit	Initial setting	Setting range	mm	4	0 to 5	μm	1	0 to 5	inch	According to the resolution of the measuring unit 0.5 μm : 5 0.1 μm : 6	0 to 7
Unit	Initial setting	Setting range											
mm	4	0 to 5											
μm	1	0 to 5											
inch	According to the resolution of the measuring unit 0.5 μm : 5 0.1 μm : 6	0 to 7											
⑧ Measuring unit information	<p>Displays detailed information about the measuring unit. The model name, serial number, firmware version, and gauge name are displayed.</p>												

[Relationship of threshold and center value]

When the comparison values C1 to C4 are set as shown below, the actual judgment values are as shown in the following table based on the center value setting. The comparator's judgment values use the center value as the standard.

	C1	C2	C3	C4
Setting value	-6	-3	3	6

Center value	C1 judgment value	C2 judgment value	C3 judgment value	C4 judgment value
2	-4	-1	5	8
0	-6	-3	3	6
-2	-8	-5	1	4

6-2. Line chart area

The current values are displayed as line graphs in real time, with the values updated at the specified interval.

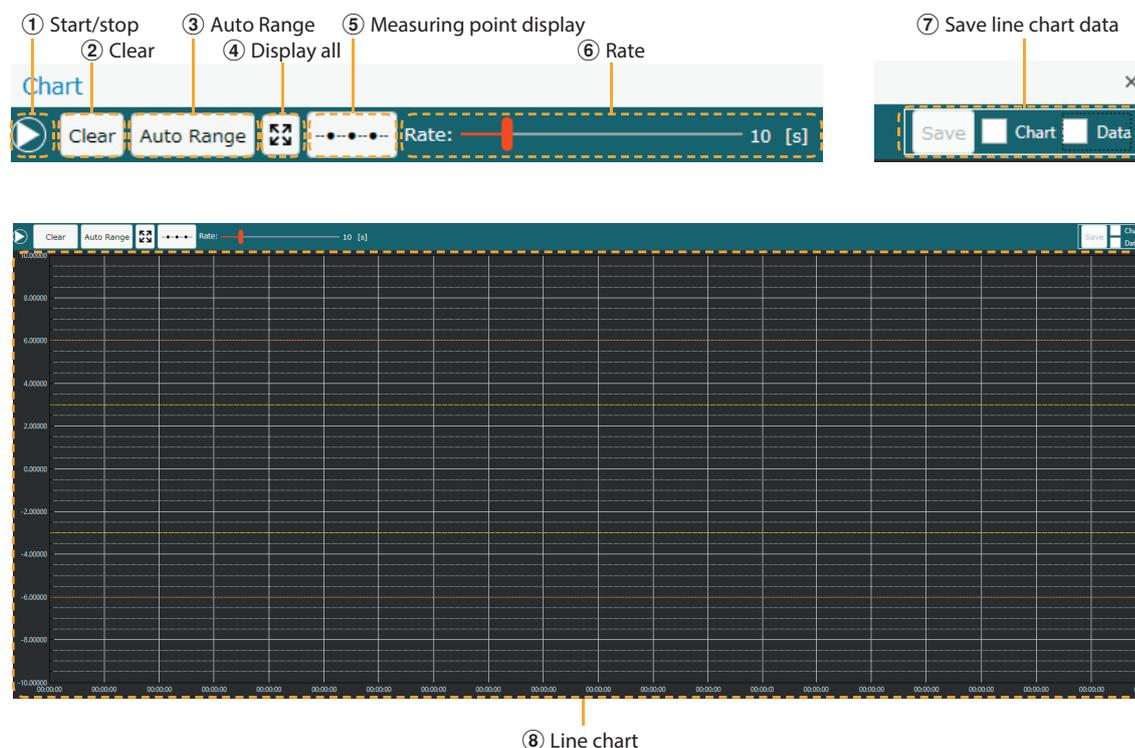

① Start/stop	Starts/stops drawing of the line chart. ▶ : Start drawing. □ : Stop drawing.
② Clear	Clears the currently displayed line chart.
③ Auto Range	Automatically adjusts the Y-axis display range. On : blue icon The display range is adjusted to match the maximum and minimum values of the entire displayed line chart. Off : white icon The range specified by the detailed settings of the selected measuring unit is used for the display.
④ Display all	Displays the entire line chart.
⑤ Measuring point display	Displays the measuring point in the line chart.

⑥ Rate	Specifies the interval for updating the line chart. Setting range: 1 to 60 seconds
⑦ Save line chart data	Saves the image or numeric value data of the displayed line chart. Chart : Saves an image of the chart to a file in png format. Data : Saves the numeric value data of the chart to a file in CSV format. The save destination is the same as that for CSV format data files. The data file is saved in an automatically generated "Chart" folder. (See section 6-4-2.)
⑧ Line chart	Displays a chart of the current values of the selected measuring unit. Selection of measuring unit to be displayed Click the Line Chart button in the detailed settings of the measuring unit to turn it On (blue). Threshold display The specified thresholds (see section 6-1-7) are displayed in the line chart as dashed lines. Click the measurement value display (see section 6-1-1) to select the measuring unit. The background of the selected measurement value display is displayed in a lighter color. Dashed yellow line : Comparator values C2 and C3 Dashed red line : Comparator values C1 and C4 Reference The Y-axis scale differs according to the display unit (mm/ μ m/inch). mm/ μ m : mm display up to the 5th decimal place inch : Display up to the number of digits displayed after the decimal point of the specified measuring unit

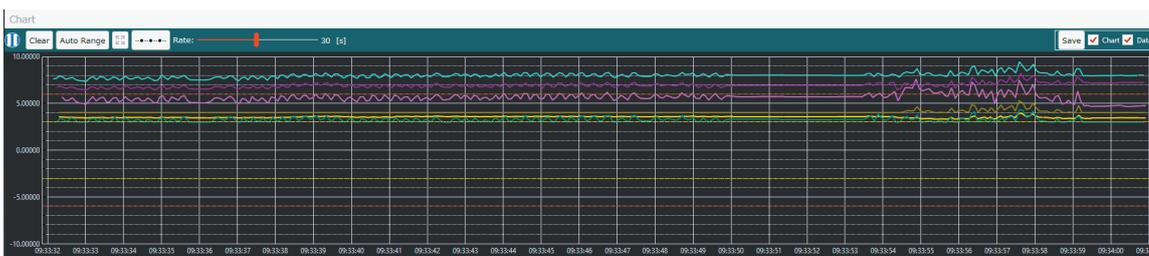

Example: 6 axes connected; Rate: 30 seconds; Auto Range: off

6-2-1. Line chart zoom-in/out and tracker display

Operations can be performed on the currently displayed chart while line chart drawing is stopped.

Operation	Effect
Left click + drag	Moves the display range
Right click + drag	Zooms the dragged range
Wheel operation	Zoom-in/out
Right double click	Display all

In addition, when the data on the chart is mouseovered, the following tracker is displayed.

- Measuring unit name
- Acquisition time
- Current value

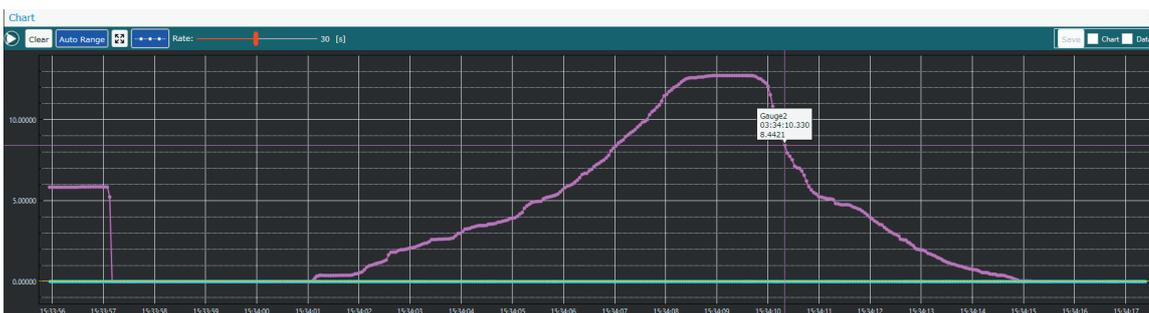

Example of display during mouseover

6-3. Data save function area

The method of acquiring measurement values and exporting acquiring measurement values in CSV format.

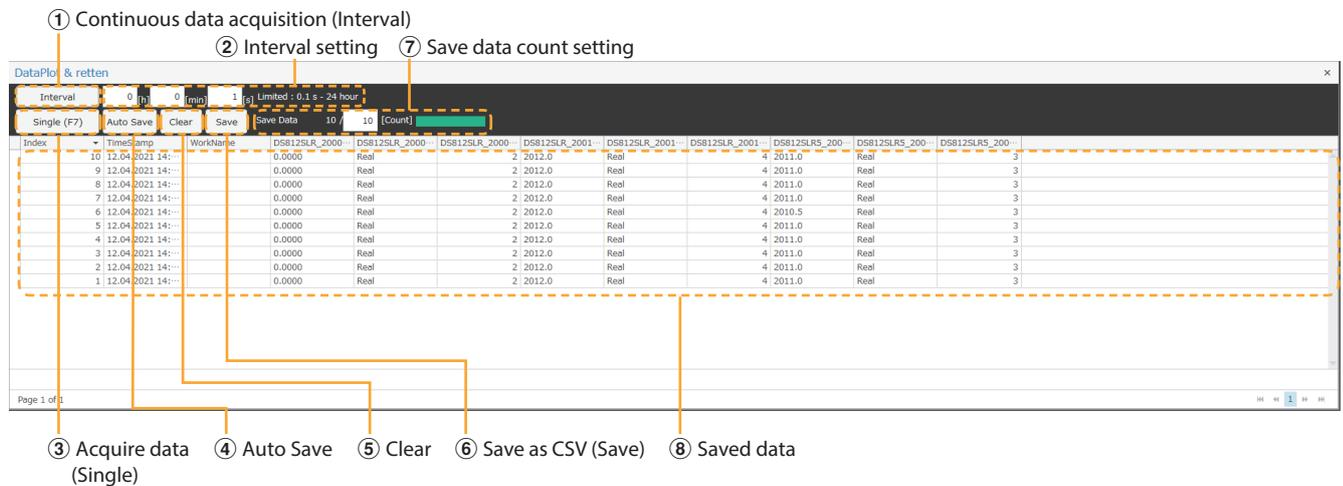

Details of acquired data

When saved data is not selected

Index	Timestamp	Work name	1st measuring unit	1st measuring unit mode	1st measuring unit judgment result	2nd measuring unit	...
	Displayed to the millisecond		Acquired value	Real Max Min P-P	0: measurement value < C1 1: C1 < measurement value < C2 2: C2 ≤ measurement value ≤ C3 3: C3 < measurement value ≤ C4 4: measurement value < C4		

When Real and P-P are selected

Index	Timestamp	Work name	1st measuring unit Real	1st measuring unit Real judgment result	1st measuring unit P-P	1st measuring unit P-P judgment result
-------	-----------	-----------	----------------------------	--	---------------------------	---

Click the Save button (Ⓜ) to output the data in CSV format.

The data is output according to the specified date format (see section 6-4-2).

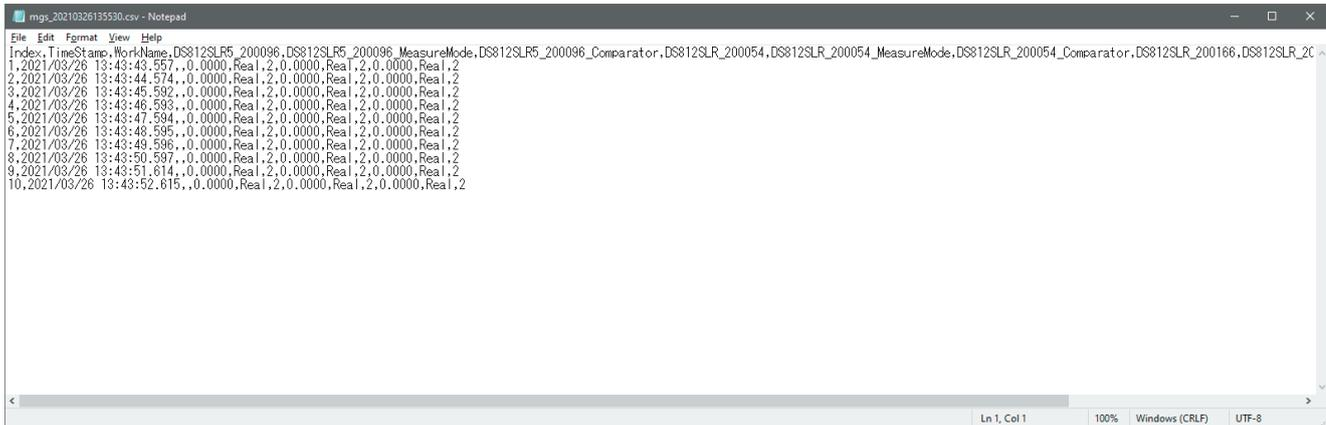

Data displayed as text file

Index	TimeStamp	WorkName	DS812SLR5_200096	DS812SLR5_200096_MeasureMode	DS812SLR5_200096_Comparator	DS812SLR_200054	DS812SLR_200054_MeasureMode	DS812SLR_200054_Comparator	DS812SLR_200166	DS812SLR_200166_MeasureMode	DS812SLR_200166_Compari
1	9:12:03		0	Real	2	0.0001	Real	2	0.0001	Real	2
2	9:12:04		0	Real	2	0.0001	Real	2	0	Real	2
3	9:12:05		0	Real	2	0.0001	Real	2	0.0001	Real	2
4	9:12:06		0	Real	2	0.0001	Real	2	0.0001	Real	2
5	9:12:07		0	Real	2	0.0001	Real	2	0.0001	Real	2

Data displayed in Microsoft Excel

6-4. Common functions

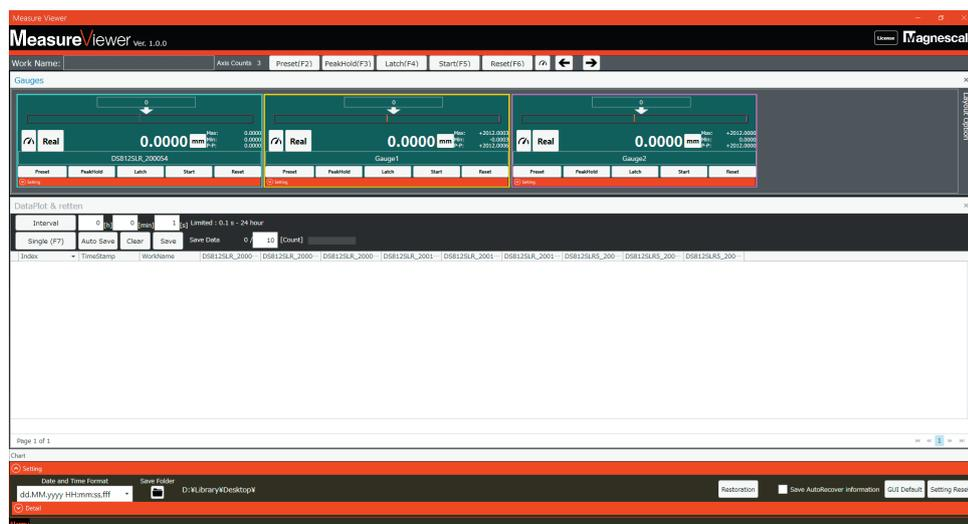

Application information/
measurement value display
operations

Common function settings
CSV format data output and
initialization settings

6-4-1. Application information and measurement value display operations

Operations can be performed on the measurement value displays of all recognized measuring units.



- ① Software version Displays the version number of the application.
- ② Work Name Entering text in this cell causes the text to be assigned to the associated acquired data and CSV output. Input conditions: Max. 32 characters that may include text, numerals, and symbols
- ③ All-axis operations (Axis Counts) These buttons allow application of Preset, PeakHold, Latch, Start, Reset, and measurement value display switching operations to all connected measuring units. Shortcut keys have been assigned to each of these functions.

Operation	Key
Preset	F2
PeakHold	F3
Latch	F4
Start	F5
Reset	F6/Delete

- ④ Rearrange measurement value displays The layout of the measurement value displays can be rearranged. Click inside the frame of the measurement value display to be moved to select it; the name of the selected measuring unit appears between the rearrange buttons. Click the right or left arrow button to move the selected display to the desired position. (The background of the selected measurement value display is displayed in a lighter color.)



- ⑤ License The measurement value displays can also be rearranged by dragging and dropping them. Click this button when the protection dongle is connected to display license information.

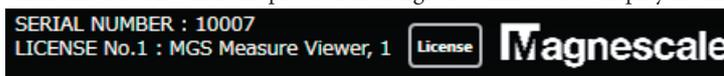

6-4-2. CSV format data output and initialization settings

Click  at the bottom of the window to enter CSV format data output and initialization settings.

CSV format data is output separated by the delimiter code used by your PC.

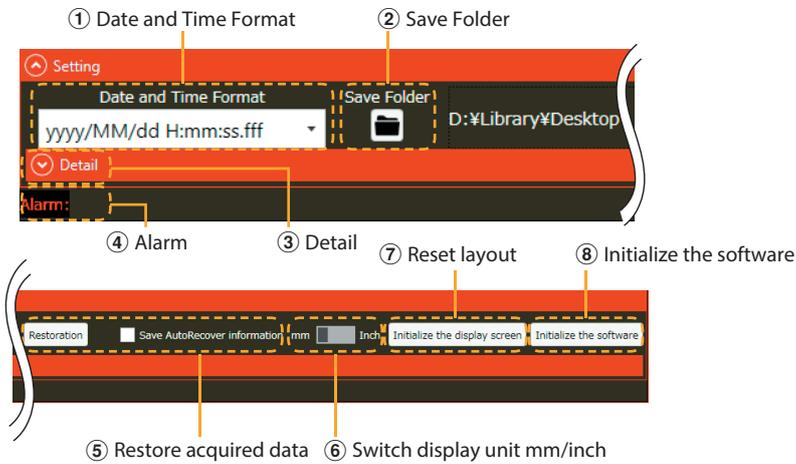

- ① Date and Time Format Selects the date and time format used when outputting acquired data and CSV format data.

Format	
M/d/yyyy h:mm:ss.fff tt	PC configuration format*, includes milliseconds
M/d/yyyy h:mm:ss tt	PC configuration format*
yyyy/MM/dd HH:mm:ss.fff	Japan format, includes milliseconds
MM/dd/yyyy HH:mm:ss.fff	U.S. format, includes milliseconds
dd.MM.yyyy HH:mm:ss.fff	EU format, includes milliseconds
yyyy/MM/dd HH:mm:ss	Japan format
MM/dd/yyyy HH:mm:ss	U.S. format
dd.MM.yyyy HH:mm:ss	EU format

* Displayed in the date and time configuration of the PC.

- ② Save Folder Specifies the destination folder for CSV format data files. The default is the desktop.

- ③ Detail Displays detailed information about the connected measuring units.

- ④ Alarm Displays information when a measuring unit generates an alarm.

- ⑤ Restore acquired data Restores the last set of acquired data.

Note

If the acquired data contains many items, restoring it may take some time.

The data used for the restore is saved automatically when the application is shut down.

Check the box next to "Save AutoRecover information" to overwrite the saved data at five-minute intervals.

- ⑥ Switch display unit mm/inch Switches the display unit to mm or inch. (For details, refer to section "6-5. Switching the display unit between mm and inch.")



Left side: mm setting Right side: Inch setting

Note

This cannot be switched during continuous data acquisition.

- ⑦ Reset layout Initializes the window layout.

When initialization is executed, the application automatically shuts down.

- ⑧ Initialize the software Initializes the application.

When initialization is executed, the application automatically shuts down.

6-5. Switching the display unit between mm and inch

When the mm/Inch setting (see section 6-4-2 ⑥) is switched, a confirmation dialog is displayed. Click "Yes" to switch the display unit.

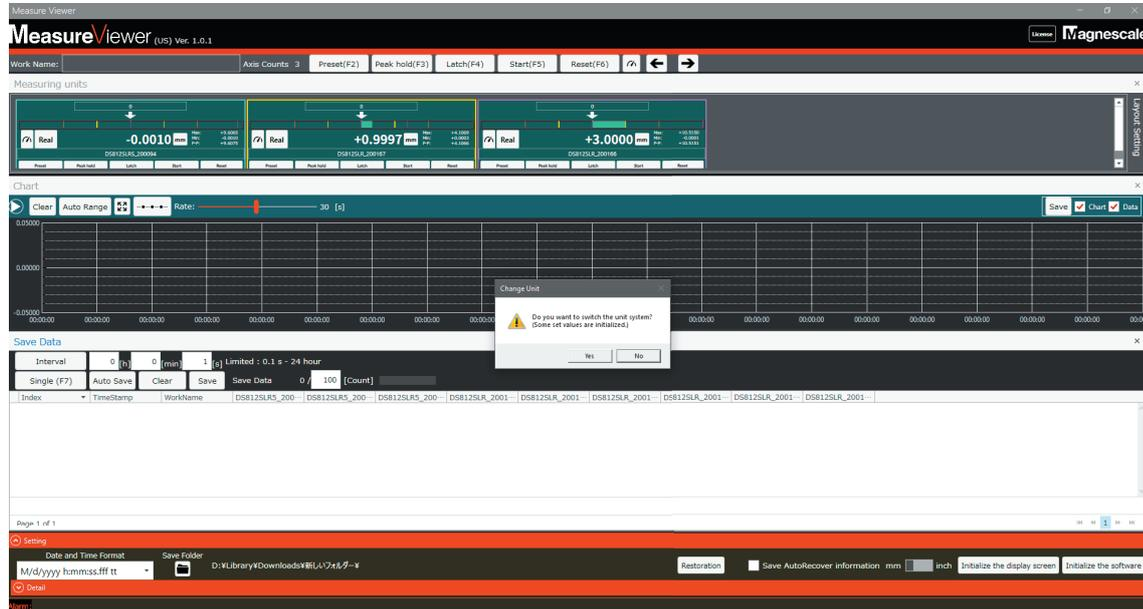

Cleared setting values

When the display unit is switched, the following setting values of all connected measuring units are cleared.

- Center value
- Preset value
- Comparison values (C1 to C4)

Measurement value display

<Numeric value display>

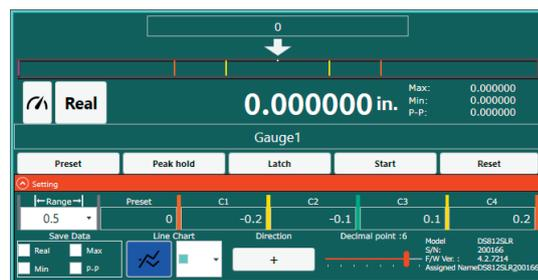
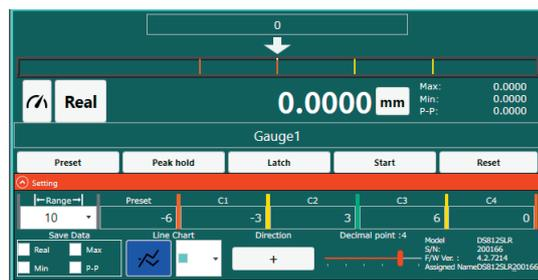

<Display with scale>

A label that indicates the size of one scale increment is displayed only when inch display is selected.



Range:0.5"
(Graduation(→ || ←):0.01")

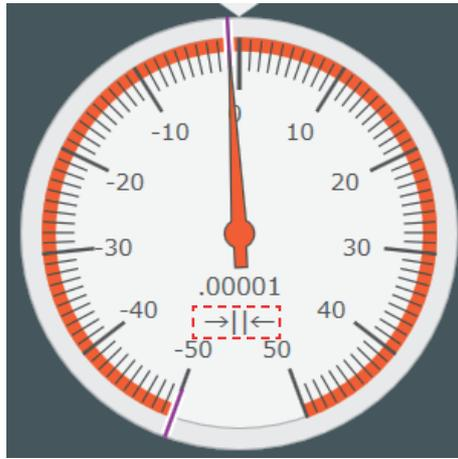

Range:0.0005"
(Graduation(→ || ←):0.00001")

The scale lines are displayed with 50 or 100 divisions according to the range.



Range:0.00025"
(Division:50)

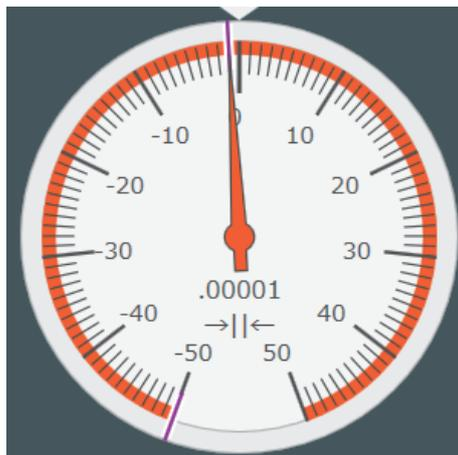

Range:0.0005"
(Division:100)

7. Troubleshooting

7-1. An alarm occurred

When a measuring unit generates an alarm, an alarm indication appears on the measurement value display of the measuring unit that generated the alarm and an alarm message is displayed.

Alarm indication on measurement value display

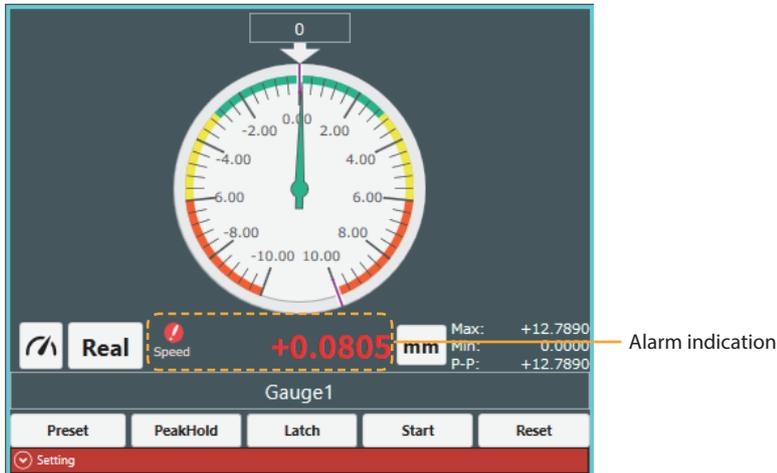

Alarm indication in common function settings area (see section 6-4-2).



Cause	Action
A measuring unit generated an alarm.	The current value of the measuring unit that generated the alarm may not be correct. Disconnect the measuring unit from the PC and then reconnect it. If reconnecting the measuring unit does not correct the problem, contact a Magnescale sales or service representative.

7-2. The installation failed

Cause	Action
(Various causes)	Possible fixes include confirming that you have administrator privileges, checking the available hard disk space, and restarting the PC. If none of these measures correct the problem, contact a Magnescale sales or service representative.

7-3. The application won't start

Cause	Action
Application is still starting up.	It is possible that the application is taking some time to start. Wait a little while.
Application did not shut down normally.	It is possible that the application did not shut down normally the last time it was run. Restart the PC.

7-4. A measuring unit is not displayed, or the numeric values are not updated

Cause	Action
The measuring unit is not connected.	Check the connection between the PC and the measuring unit. (If they are properly connected, the LED on the interpolator of the measuring unit will be flashing blue or steadily lit blue.)
The measuring unit was not properly recognized by the PC.	If the LED of the measuring unit connected to the PC is not lit or flashing or steadily lit red, the power supply to the measuring unit may be insufficient. Check the supply of power via the USB port and the number of connections.
17 or more measuring units are connected.	The application supports connection of up to 16 measuring units. Ensure that no more than 16 measuring units are connected.
The settings made by the application are not applied.	If measuring unit settings by the application fail, the measuring unit may not be displayed. Disconnect the measuring unit from the PC, and then reconnect it. If reconnecting the measuring unit does not correct the problem, disconnect the measuring unit from the PC, initialize (see section 6-4-2) and restart the application, and then reconnect the measuring unit.
A COM port number that does not enable communication is recognized.	Communication may not be possible depending on the COM port number automatically allocated to the measuring unit. In that case, change the COM port number of the target measuring unit, and then reconnect the measuring unit. <Changing the COM port number> 1. Right click the Start button of the PC and open the "Device Manager." 2. Expand Ports (COM/LPT).

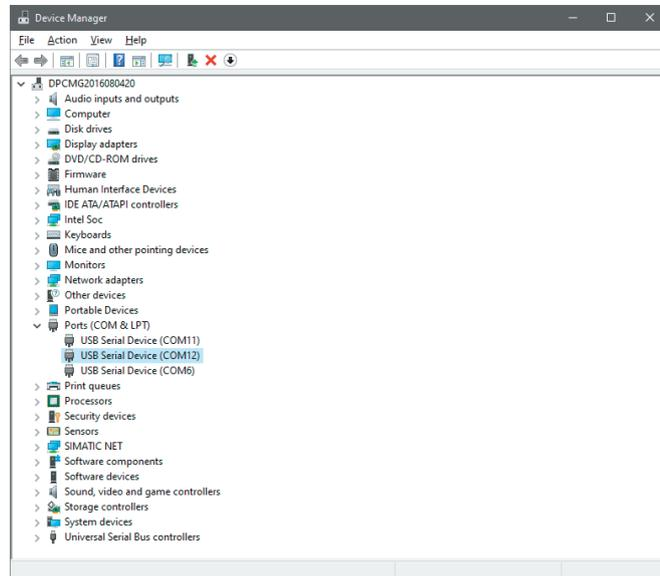

- When the target measuring unit is disconnected from the PC, the number of devices under Ports (COM/LPT) on the screen changes, so check the COM number of the measuring unit.

- Open the COM properties of the target measuring unit, click the "Port Settings" tab, and click the "Advanced" button.

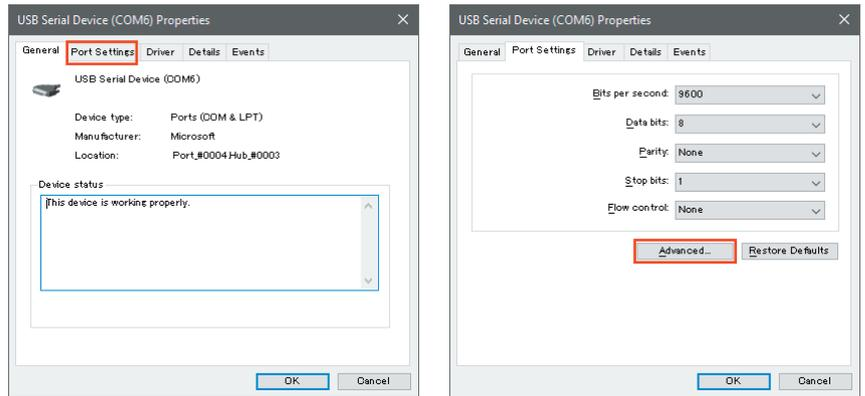

- Change "COM Port Number" at the bottom of the opened window to a different value, and click "OK."

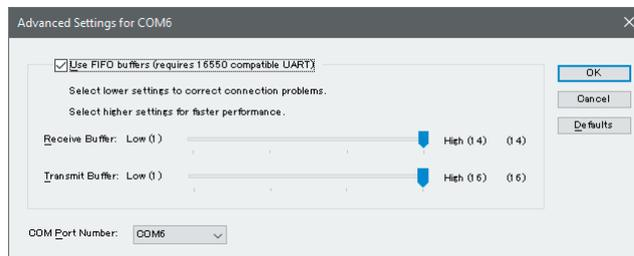

- Restart the application.

7-5. The application suddenly shuts down

Cause	Action
The protection dongle is not connected.	The application performs a forced shutdown after five minutes if the protection dongle is not connected to the PC. Make sure the protection dongle is connected when using the application.
The protection dongle is not recognized.	The protection dongle may not be properly recognized. Restart the PC and restart the application.
Exception handling occurred.	The application may perform a forced shutdown if an unexpected operation occurs. Restart the PC and check the operation of the application.

このマニュアルに記載されている事柄の著作権は当社にあり、説明内容は機器購入者の使用を目的としています。したがって、当社の許可なしに無断で複製したり、説明内容（操作、保守など）と異なる目的で本マニュアルを使用することを禁止します。

本手册所记载的内容的版权归属Magnescale Co., Ltd.，仅供购买本手册中所记载设备的购买者使用。

除操作或维护本手册中所记载设备的用途以外，未经 Magnescale Co., Ltd. 的明确书面许可，严禁复制或使
用本手册的任何内容。

The material contained in this manual consists of information that is the property of Magnescale Co., Ltd. and is intended solely for use by the purchasers of the equipment described in this manual.

Magnescale Co., Ltd. expressly prohibits the duplication of any portion of this manual or the use thereof for any purpose other than the operation or maintenance of the equipment described in this manual without the express written permission of Magnescale Co., Ltd.

Le matériel contenu dans ce manuel consiste en informations qui sont la propriété de Magnescale Co., Ltd. et sont destinées exclusivement à l'usage des acquéreurs de l'équipement décrit dans ce manuel.

Magnescale Co., Ltd. interdit formellement la copie de quelque partie que ce soit de ce manuel ou son emploi pour tout autre but que des opérations ou entretiens de l'équipement à moins d'une permission écrite de Magnescale Co., Ltd.

Die in dieser Anleitung enthaltenen Informationen sind Eigentum von Magnescale Co., Ltd. und sind ausschließlich für den Gebrauch durch den Käufer der in dieser Anleitung beschriebenen Ausrüstung bestimmt.

Magnescale Co., Ltd. untersagt ausdrücklich die Vervielfältigung jeglicher Teile dieser Anleitung oder den Gebrauch derselben für irgendeinen anderen Zweck als die Bedienung oder Wartung der in dieser Anleitung beschriebenen Ausrüstung ohne ausdrückliche schriftliche Erlaubnis von Magnescale Co., Ltd.

日本からの輸出時における注意

本製品(および技術)は輸出令別表第1の16の項(外為令別表16の項)に該当します。キャッチオール規制による経済産業省の許可要否につきましては、輸出者様にてご確認ください。

For foreign customers

Note: This product (or technology) may be restricted by the government in your country. Please make sure that end-use, end user and country of destination of this product do not violate your local government regulation.

Magnescale Co., Ltd.

45 Suzukawa, Isehara-shi, Kanagawa 259-1146, Japan